

COMPUTATIONAL FLUID DYNAMIC (CFD) SIMULATION ON REDESIGN BAFFLES OF YOGYAKARTA INTERNATIONAL AIRPORT TRAIN FUEL TANK

Putri Novia

Rollingstock Engineering
Madiun State Polytechnic
Email: putri.novia00@gmail.com

Bi Asngali

Rollingstock Engineering
Madiun State Polytechnic
Email: biasngalimt@pnm.ac.id

Agus Susanto

Rollingstock Engineering
Madiun State Polytechnic
Email: agus_eng.dept@pnm.ac.id

Riant Adzandy

PT. Industri Kereta Api (Persero)
Email: riant.adzandy@gmail.com

Hedi Purnomo

PT. Industri Kereta Api (Persero)
Email: hedi.purnomo@inka.co.id

ABSTRAK

Tangki merupakan salah satu komponen terpenting dalam kereta api yang berfungsi sebagai tempat untuk menyimpan bahan bakar kereta api. Namun selama ini tangki menjadi komponen yang luput dari pengamatan, padahal ada permasalahan yang sangat penting untuk diperhatikan yaitu bagaimana pergerakan fluida di dalam tangki akibat gerakan dari kereta saat melaju. Gerakan bebas dari fluida cair di dalam sebuah tangki disebut *sloshing*. *Sloshing* pada tangki bisa direduksi dengan menambahkan anti-*sloshing* di dalam tangki yang disebut dengan komponen *baffles*. Maka perlu adanya simulasi *sloshing* akibat pergerakan kereta dengan memperhatikan nilai *vehicle subsystem* kereta serta variasi desain *baffles* yang digunakan. Ada beberapa model *baffles fuel tank* yang digunakan pada penelitian ini, yaitu *fuel tank* tanpa *baffles*; *longitudinal baffles* (2) *lateral baffles* (1) - *baffles existing*; *longitudinal baffles* (3) *lateral baffles* (3) dengan pelubangan berbentuk lingkaran; dan *horizontal* (2) *lateral* (1) *baffles* dengan pelubangan berbentuk lingkaran. Penelitian ini bertujuan memberikan konfigurasi desain *baffles* yang secara optimal dapat mereduksi *sloshing* yang terjadi. Maka dalam penelitian ini dilakukan simulasi pada *fuel tank* dengan variasi *baffles* di dalamnya dengan menerapkan metode *Computational Fluid Dynamic* (CFD). Dari hasil simulasi disimpulkan bahwa konfigurasi *longitudinal baffles* (3) *lateral baffles* (3) memiliki performa terbaik dengan efektifitas sebesar 34.33% dalam mereduksi *sloshing*.

Kata kunci: sloshing, baffles, fuel tank, Computational Fluid Dynamic (CFD), fluida.

ABSTRACT

The tank is one of the most important components in the train which serves as a place to store train fuel. However, so far the tank has been a component that has gone unnoticed, even though there is a very important issue to consider, namely how the fluid moves in the tank due to the movement of the train while moving. The free movement of the liquid fluid in a tank is called sloshing. Sloshing in the tank can be reduced by adding anti-sloshing in the tank called component baffles. So it is necessary to simulate the sloshing due to the movement of the train by taking into account the value of the vehicle subsystem of the train and the variation of the baffles design used. There are several models of fuel tank baffles used in this study, namely fuel tanks without baffles; longitudinal baffles (2) lateral baffles (1) - existing baffles; longitudinal baffles (3) lateral baffles (3) with circular perforations; and horizontal (2) lateral (1) baffles with circular perforations. This study aims to provide a baffles design configuration that can optimally reduce the sloshing that occurs. So in this study, a simulation of the fuel tank with variations in the baffles was carried out by applying the Computational Fluid Dynamic (CFD) method. From the simulation results, it is concluded that the configuration of longitudinal baffles (3) lateral baffles (3) has the best performance with an effectiveness of 34.33% in reducing sloshing.

Keywords: sloshing, baffles, fuel tank, Computational Fluid Dynamic (CFD), fluid.

1. INTRODUCTION

The tank is one of the most important components in the train which serves as a place to store train fuel. The tank includes components that can be customized, which means its construction and strength can be changed. Basically the shape of the fuel tank will vary depending on the type of train.

PT. INKA (Railway Industry) is an integrated railways manufacturing industry, which will often use tanks for train fuel which are original products produced directly at PT. INKA. There is a very important thing to note in the use of the tank, namely how the liquid in the tank is due to the movement of the train when it is running.

The free movement of liquid in a tank is called sloshing. Sloshing or often referred to as hilarious is a condition where the fluid in the container is not in a straight line, causing the tension in the container to change. Sloshing can be understood as the free movement of a liquid in a container [1].

The occurrence of sloshing has an impact in the form of impact loads that can cause structural damage to tank components [2]. According to Rognebakke et. al, (2009), the movement of fluids in addition to causing structural damage is also capable of disrupting the stability of the movement of the vehicle itself. Especially if it is noticed that the train does not actually have a stable movement when traveling on rail crossings. There are several movements experienced by trains including lateral, longitudinal, sagittal-horizontal movements. The movement of the train is mainly influenced by the terrain of the rail crossing, the difference in height between two parallel rails, turns, the height of the rails, and several other conditions. This condition causes sloshing in the tank.

Sloshing on the tank can be reduced by adding anti-sloshing in the tank. Anti-sloshing is commonly known as component baffles. There are many researchers who conduct research to find a model or design of baffles to reduce sloshing in the tank.

The use of vertical baffles in a box-shaped fluid tank is a passive technique and includes a fixed structure in the tank which has been shown to reduce sloshing in the tank [3]. The effect of the vertical height of the partitions/baffles on the tank can also affect the sloshing wave. The higher the vertical baffles dimension, the smaller the sloshing wave and the lower the sloshing impact pressure effect [4]. Jin et. al, (2014) have also shown that the effect of baffles that are placed horizontally and in the middle of the fluid level and with the dimensions and patterns of perforations are proven to reduce the impact of sloshing.

The number of technologies that are developing rapidly today, there are many software that can be used to calculate and simulate the design model of baffles for tank trains that are in operation. One of them is CFD is a computer device that can be used to solve and analyze problems involving fluid flow.

Computational Fluid Dynamics (CFD) is a method that uses various fields of science and applied mathematics to model, predict and visualize a fluid, both gaseous and liquid through computational means [5].

The sloshing effect is the result of the free surface area of the fluid in the tank. Therefore, this study will analyze the sloshing motion of the fuel tank, especially on the Yogyakarta International Airport Train (KA YIA). By using the CFD method, it is expected to get results in the form of a comparison of the sloshing motion of the existing tank baffles design with the redesign of the baffles using variations in the placement or number of baffles. So it is hoped that a design configuration that can optimally be applied to YIA trains will be obtained.

2. METHODOLOGY

This section will describe the methods and stages that will be used as references in carrying out research, namely the tools used, research methods, research data processing, fuel tank modeling, running processes and simulations.

2.1 Tool

In this study there are several tools used, including:

- Vernier calipers
- Meter
- Applications Accelerometer Sensor
- Modeling and Design Software (Autodesk Inventor Professional 2021 Student Version)
- CFD Simulation Software
- Graph Grabber Software
- Personal Computer (PC) with type DELL OPTIPLEX 7070MT-9700- WINPRO to run simulation
- Laptop with Lenovo Ideapad 110 type to do design modeling

2.2 Research Methods

The method used in this research is the redesign or redesign phase and simulation and data processing. The redesign stage was carried out to model variations in the fuel tank baffles of YIA Airport Train. The simulation stage is carried out using the CFD method, where the simulation is carried out with the aim of finding an overview through a system that will be carried out.

The literature study and data collection stages were carried out at PT INKA (Persero). The stage of observation and inspection of the physical structure of the tank was carried out at the Yogyakarta Locomotive Depot. Then the data obtained will be made a modeling, calculation and simulation with the CFD method which is carried out at Campus 1 of the Madiun State Polytechnic.

2.3 Research Data Processing

This study focuses on evaluating the effect of sloshing fuel tanks due to variations in the placement of baffles on the movement of the train. The simulations carried out in this study are useful for knowing the characteristics of each baffles design variation by taking into account the variables used in the study, namely the independent and dependent variables. The independent variables used were the configuration of the baffles placement, the shape and size of the baffles, and the number of baffles plates. The dependent variable that is used as a reference in the study is the shape, volume, and dimensions of the tank.

2.3.1 Existing Fuel Tank Modeling (Longitudinal (2) Lateral (1) Baffles)

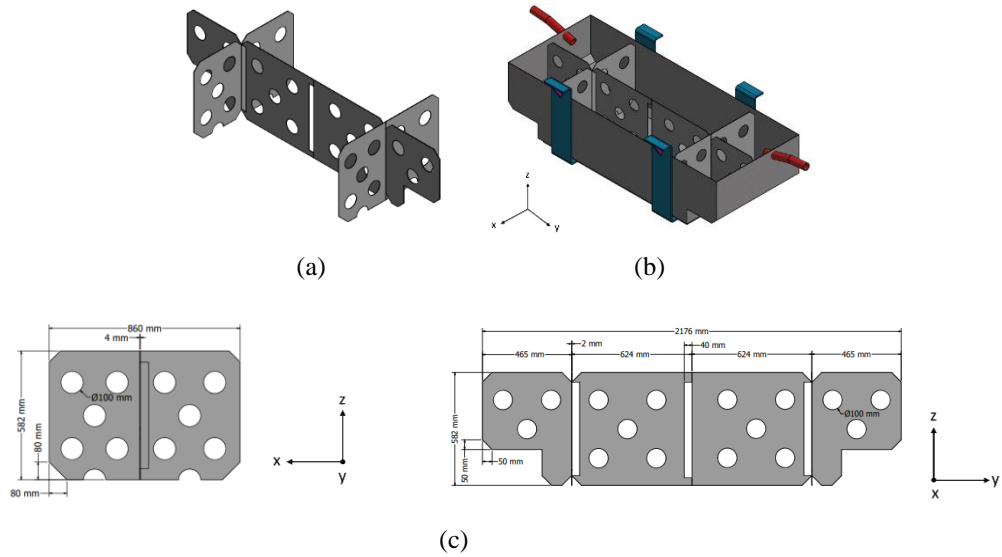

Figure 1. (a) Configuration Existing Baffles (b) Existing Fuel Tank Design; (c) Detail of Design Hole Baffles

2.3.2 Existing Fuel Tank Modeling (Longitudinal (2) Lateral (1) Baffles)

- Fuel Tank without Baffles

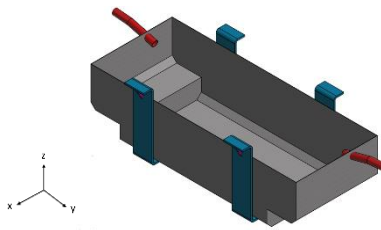

Figure 2. Fuel Tank Without Baffles

- Longitudinal (3) Lateral (3) Baffles with Circle Perforation

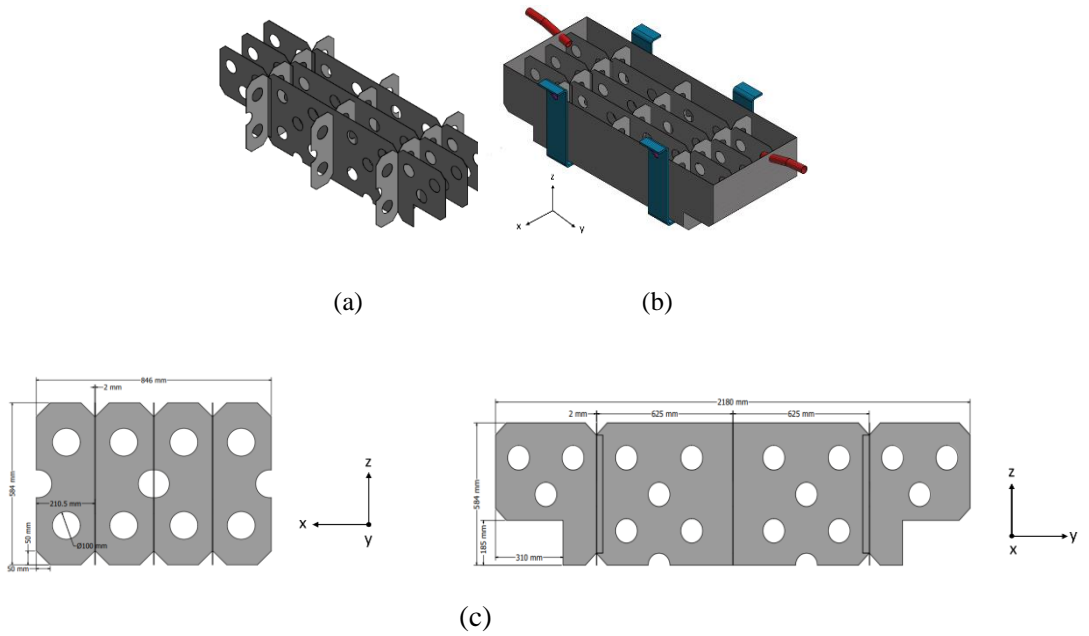
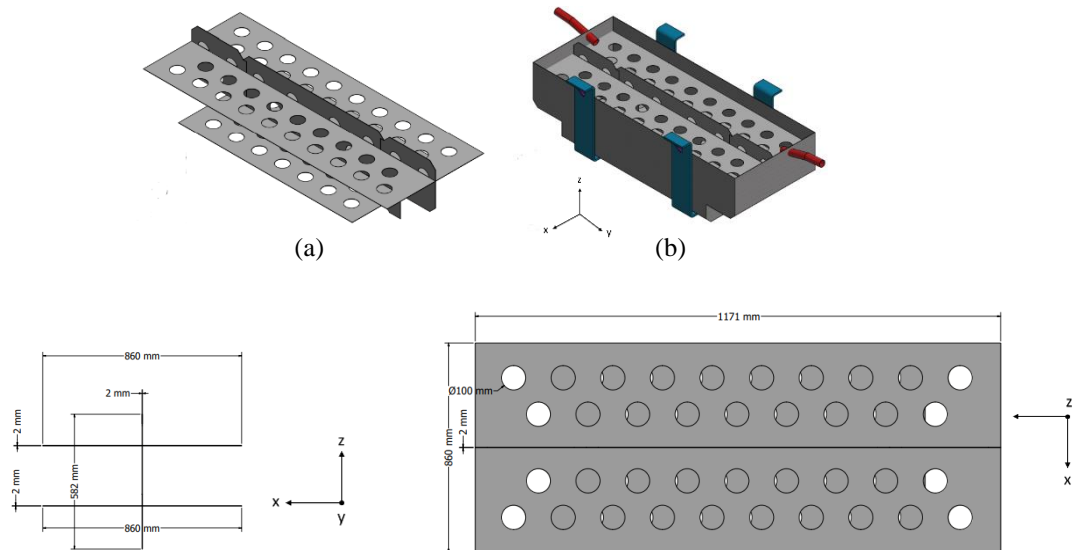
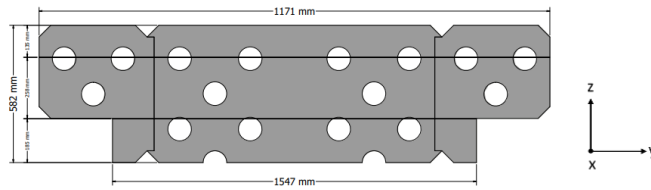

Figure 3. (a) Longitudinal (3) and Lateral (3) Baffles; (b) Longitudinal (3) and Lateral (3) Baffles Placement; (c) Detail of Design Hole Baffles

- Horizontal (2) Lateral (1) Baffles, with a circular hole





(c)

Figure 4. (a)Lateral (1) and Horizontal (2) Baffles Models; (b) Placement of Lateral (1) and Horizontal (2) Baffles Models on the Tank; (c) Detail of Design Hole Baffles

2.3.3 Sloshing Movement Simulation with Computational Fluid Dynamic (CFD) Method

In the simulation of the CFD model, there are three stages that must be carried out including:

- Pre-Processing

Pre-Processing is the first step in analyzing a CFD model. The technique is to create a 3D model of the object to be analyzed, perform meshing, then apply boundary conditions and fluid properties (boundary conditions).

Development grid/meshing the process of dividing a geometric domain into several parts cell. The results of meshing are very influential in determining the output of the simulation, therefore meshing is often said to be one of the important processes in the CFD method.

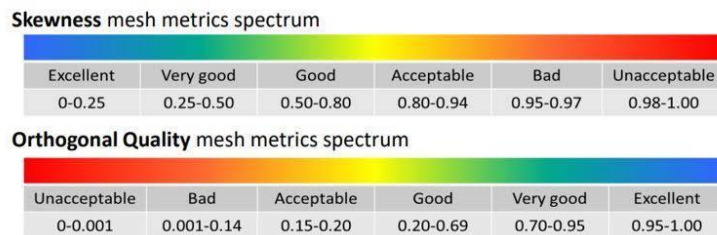

Figure 5. Mesh Metrics Spectrum [6]

All tank models use a mesh with a tetrahedron type. Mesh with the tetrahedron type is very commonly used because of its advantages, which are very adaptive to complex geometric shapes or curve shapes.

- Solver

The next stage is Processing/solver, where at this stage several input problems will be entered as parameters according to the rules in the CFD software, one of which is the YIA train acceleration input because this acceleration causes movement in the fluid (sloshing).

And after that, the process of calculating the input data with the equations involved iteratively will be carried out. Input from boundary conditions is needed to translate the conditions of objects and fluids, so that calculations can be done by software.

The fluid flow in this study is incompressible and the flow velocity changes with time Solver-Type chosen Pressure Based and part Solver-Time chosen Transient. Type Pressure Based used for flow simulation incompressible. Then choice Gravity is also activated because it is necessary to enter the value of the acceleration of the train.

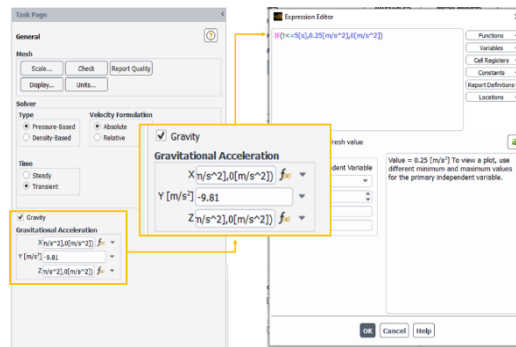

Figure 6. Equation Settings Acceleration

This study uses a model Multiphase-Volume of Fluid which is where this model is used for simulations that have interface clear which separates the 2 phases between air and liquid (diesel-fuel) because the fuel material used in the simulation is diesel-fuel.

Then the selection of this simulation method is based on a higher level of approximation relationship between pressure and velocity correction factors. The PISO algorithm is highly recommended for all transient flow calculations. The PISO method uses two additional correction factors to improve calculation efficiency, namely Neighbor Correction and Skewness Correction.

The essence of the solving stage is to carry out the calculation process or running calculations with running data that has been input in the previous stages. The solving stage includes the execution of simulations on the model. Calculations in CFD simulations are iterative. This simulation uses the time function time-step because it is a sloshing simulation, that is Time Step Size(s) to be filled in 0.02 and Number of Time Steps is 350 so the time used is 7 s (the result of multiplying the two). With Iterations/Time Step 10, meaning that each step of the execution time is repeated 10 times.

- Post Processing (Analyse and Visualize)

The last stage is to represent the calculation results from the solver stage in the form of images, graphics, and even animations with certain patterns. The calculation results can be seen in the form of numerical data and visual data of fluid flow in the model.

3. RESULTS AND ANALYSIS

3.1 Meshing Quality

Mesh included in the complicated stages of CFD simulation. If there is an inaccuracy / error in the meshing, it can cause the simulation to be error and failed. So if that happens, then this step must be repeated. The larger the number of elements of the meshing, the better and more accurate the simulation results will be, but it will affect the solving process which will be heavier and take a long time.

In this study, the focus of the author is to do meshing by achieving certain value conditions according to the acceptance value in the Fluent simulation to be carried out. In the CFD simulation, especially the Fluent stage, the acceptance of the meshing value is more focused on the value Minimum Orthogonal Quality which cannot be < 0.01. And the quality of meshing can also be matched with the mesh metrics in Figure 5.

3.1.1 Fuel Tank No Baffles

Table 1. Quality Meshing Tank Without Baffles

	<i>Aspect Ratio</i>	<i>Quality Element</i>	<i>Orthogonal Quality</i>	<i>Skewness</i>
Min	1.1752	0.09282	0.064591	0.00085724
Max	25,337	0.99946	0.9938	0.93541
Average	1.8642	0.82695	0.75608	0.24298

3.1.2 Longitudinal (2) Lateral (1) Baffles – Existing Baffles

Table 2. Quality Meshing Tank with Existing Baffles

	<i>Aspect Ratio</i>	<i>Quality Element</i>	<i>Orthogonal Quality</i>	<i>Skewness</i>
Min	1.1743	0.026457	0.01925	0.0010782
Max	67.058	0.99933	0.9936	0.98075
Average	1.8609	0.82802	0.75861	0.2405

3.1.3 Longitudinal (3) Lateral (3) Baffles with Circle Perforation

Table 3. Quality Tank Meshing with Longitudinal (3) - Lateral (3) Baffles

	<i>Aspect Ratio</i>	<i>Quality Element</i>	<i>Orthogonal Quality</i>	<i>Skewness</i>
Min	1.168	0.40846	0.22344	0.0003866
Max	5.1832	0.9998	0.9926	0.77656
Average	1.8547	0.82892	0.76015	0.23892

3.1.4 Horizontal (2) Lateral (1) Baffles with Circle Perforation

Table 4. Quality Meshing Tank with Horizontal (2) Lateral (1) Baffles

	<i>Aspect Ratio</i>	<i>Quality Element</i>	<i>Orthogonal Quality</i>	<i>Skewness</i>
Min	1.1738	0.013559	0.0122747	0.0011336
Max	138.07	0.99939	0.9934	0.98725
Average	1.8567	0.82844	0.7596	0.23947

3.2 Simulation Results

The purpose of this study is to find the value of the force that causes sloshing on the train tank wall. Fluids are yields even though the stress that occurs is very small, so it cannot cause a concentrated force so that all the forces given to it will be distributed evenly throughout the volume (mass) or in the direction of the surface [7]. So the force value here can be said to be the force acting on each fluid volume, namely the inertial force (body force) and the surface force (surface force).

The inertial force (body force) is proportional to the mass of the fluid or the volume of the fluid. This is arises due to the presence of gravity, and the force experienced by fluid in a vessel or tank that is moving with acceleration, or fluid flowing with acceleration in a stationary channel. This force works without any

physical contact where the force is distributed throughout the fluid element [8]. Meanwhile, in this study, the force that influences is the force of gravity and the acceleration of the tank so that there is a sloshing (wave).

The surface force is distributed continuously over the entire surface of the fluid and if it is evenly distributed it will be proportional to the outside of the surface. Surface force is the force that acts on the boundary/surface of the fluid through physical contact, consisting of a compressive force or pressure and a shear force [7]. It can be said that this arises due to the influence of the fluid environment under consideration or due to the influence of other objects that are in contact with the volume in this case the inner walls of the tank and the baffles which in this simulation are both defined as walls.

From the simulation results, there are differences in the forces acting on the four tank models. The graph below will show how the force that occurs on the walls of each tank model.

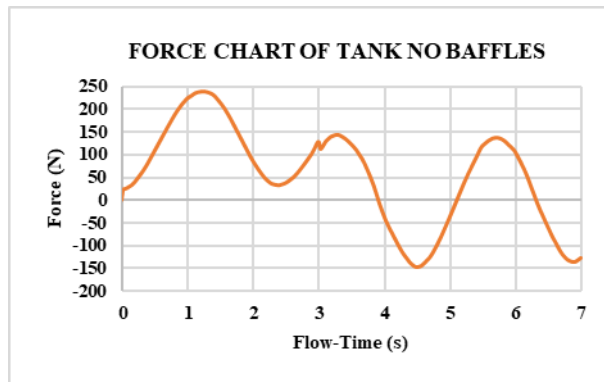

Figure 7. Chart Force Simulation Results Tank Without Baffles

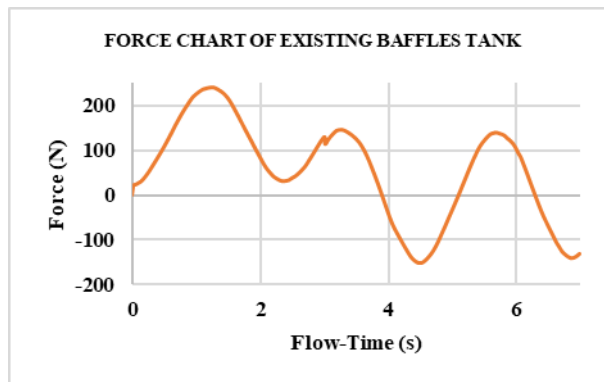

Figure 8. Chart Force Simulation Result of Existing BafflesTank

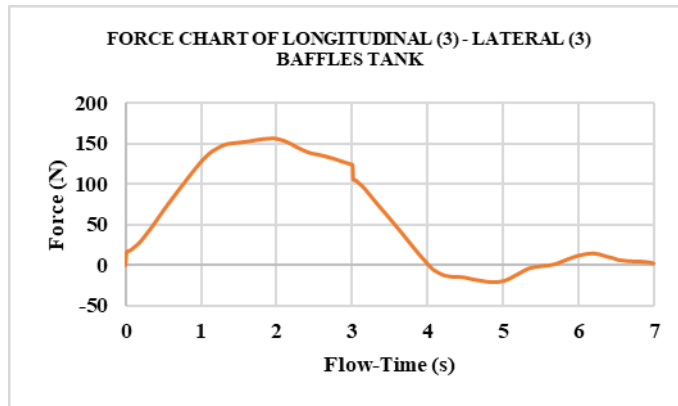

Figure 9. Chart Force Simulation Result Longitudinal (3) - Lateral (3) Baffles Tank

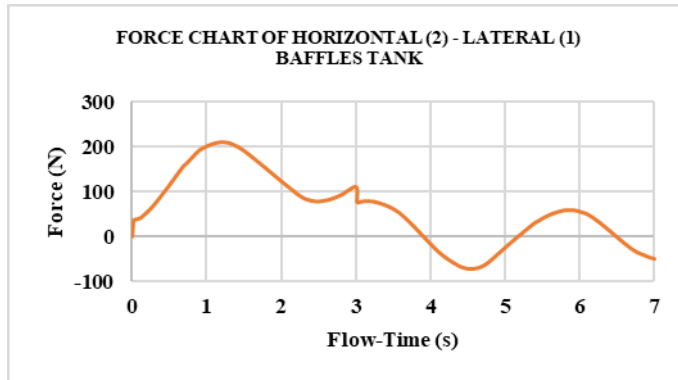

Figure 10. Chart Force Simulation Result Horizontal (2) - Lateral (1) Baffles Tank

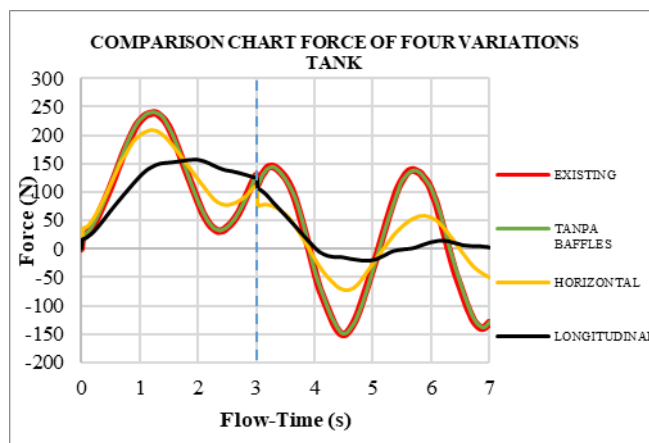

Figure 11. Value Comparison Chart Force Four Variations Tank

Figure 11 shows a graph of the force value comparison curve of the four tank geometry models. The comparison of the curves shows that there is a similarity in the shape of the curve in the existing baffles tank model with the tank without baffles. The difference in the resulting values is also very small. This is due to the size of the space resulting from the partition of the baffles in the existing tank which is still too large in the middle area, so it is considered unable to absorb fluid shocks, even the results are the same as the force generated by shocks in the tank without baffles. In addition, another cause that causes the similarity of the graph is that the fluid waves that occur are identical to the baffles / barriers, a sinusoidal wave or half wave of the fluid coincides with the location of the barrier so that the baffles cannot work according to their function as a barrier or breakwater. In this case, the author can provide redesign ideas on the existing model by changing the diameter of the circle on the baffles holes to be smaller and changing the location of the baffles, even though using the existing configuration. It is possible to have an impact in the form of limiting fluid flow when a shock occurs, so that the shock is not transmitted to the opposite side of the tank but can be resisted by the wall of the baffles, even though using the existing configuration. It is possible to have an impact in the form of limiting fluid flow when a shock occurs, so that the shock is not transmitted to the opposite side of the tank but can be resisted by the baffles wall.

Then the tank model curve with horizontal baffles configuration shows a decrease in the force value caused by sloshing on the tank wall. The location of the baffles in a horizontal orientation is considered to be more capable of reducing sloshing compared to the existing tank model, although it has not yet been able to reach steady.

The best baffles configuration to reduce sloshing is the longitudinal baffle configuration. This excellent ability can be seen from the difference in the value of the force generated by sloshing against the tank wall compared to other tank models. This is due to the division (partition) of space by quite a lot of baffles, so that the fluid area is smaller and results in a more limited fluid shock motion area. The difference in fluid movement in the four tanks can be seen in Appendix.

Figure 11 also shows a review of two areas, namely before and after 3 s. The first focus is on the area before 3 s. The arrangement of the magnitude of the train's acceleration in the simulation has been explained that at 0 – 3 s the direction of the train movement (X axis) is 0.5 m/s² and the lateral direction (Y axis) is 0.25 m/s². When reviewing the large-force comparison plot in the area is seen peaks that occur both maximum and minimum from each design of the tank baffles. This value can be seen on Table 5 as follows.

Table 5. Force Value at Time 0 - 3 s

Model	Force(N)		Peak Max Reduction Percentage (Compared to Existing Model)	Mean Force On Time 0 – 3 s
	Peak Maximum	Peak Minimum		
Tank without baffles	239.4	32.1	0.12 % (relatively the same)	122.29
Existing baffles	239.7	31.6	-	122.58
Longitudinal (3) - lateral (3) baffles	157.2	-	34.33%	118.06
Horizontal (2) - lateral (1) baffles	209.3	77.6	12,57 %	129.13

From the table it can be seen that the baffles configuration that has great potential in reducing the occurrence of sloshing in the fuel tank is baffles with a longitudinal configuration (3) - lateral (3) with a percentage of 34.33%. The percentage value is obtained by comparing the maximum peak size in the existing tank model.

The translation of the values above can also be seen that the maximum peak of the longitudinal baffles is smaller than that of the horizontal baffles. And from a review of the mean force, longitudinal baffles also

produce a lower mean force than the other baffles models. The mean force shows the dynamic load received by the tank wall. This can indicate that the fuel tank with the longitudinal (3) – lateral (3) baffles configuration can absorb shocks or loads continuously as well as shock loads on the train, seen in the shape of the curve that does not have fluctuation ripples.

Then when viewed from the second area, namely the area after 3 s. The setting of the magnitude of the train's acceleration in the simulation has been explained that in seconds > 3 s in the direction of train movement (X axis) and lateral direction (Y axis) is 0 m/s². This value is to determine the response of the baffles in the face of different train conditions. The peak values that occur in these areas can be seen in the following Table 6.

Table 6. Force Value When Time >3 s

Model	Force (N)		Towards Steady at Second Second
	Peak Maximum	Peak Minimum	
Tank without baffles	143.9	-147.8	Not steady
Existing baffles	144.7	-150.6	Not steady
Longitudinal (3) - lateral (3) baffles	14.6	-20.8	7 s
Horizontal (2) - lateral (1) baffles	58.5	-72.6	Not steady

From the table it can be observed that the force curve on the tank without baffles, the configuration of existing baffles and the configuration of horizontal baffles has not been able to reach steady even until the end of the flow-time setting of the simulation is complete. However, the force curve in the longitudinal (3) lateral (3) configuration was able to reach steady around 7 s. This also indicates that the longitudinal baffles configuration is able to provide a fast response to changes in conditions both acceleration and deceleration that occur on the train.

5. CONCLUSION

From the simulations that have been carried out, the following conclusions can be drawn:

- Sloshing that works on the existing tank wall occurs very significantly. It is evident from the force graph which shows fluctuations from the beginning to the end of the simulation flow time. Even the results have similarities with the tank model without baffles. The value is relatively the same, the highest maximum peak in the tank without baffles is 239.4 N while in the existing tank is 239.7 N, both occur at 1.2 s.
- The results of the redesign of baffles on tanks with longitudinal (3) - lateral (3) baffles configurations and horizontal (2) - longitudinal (1) baffles configurations are considered to be able to reduce the occurrence of sloshing, but the best performance is shown by longitudinal baffles configurations with an effectiveness of 34.33%, while the horizontal baffles configuration only shows an effectiveness of 12.57%.
- The effective baffles configuration applied to fuel tanks YIA railway is baffles with longitudinal (3) - lateral (3) baffles configurations.

ACKNOWLEDGEMENT

Thank you to the Head of Yogyakarta Locomotive Depot and staff who have accepted and allowed the author to make observations so that the research can be carried out properly

REFERENCE

- [1] Arsad, A. K. dan Sulisetyono, A. 2013. Studi Gerakan Sloshing terhadap Tangki Kotak (Rectangular Tank) Dengan dan Tanpa Pelat Memanjang (Baffle) Akibat Gerakan Rolling Kapal Dengan Metode Computational Fluid Dynamics (CFD). *Jurnal Teknik Pomits*. Vol. 2, No. 1, (2013) ISSN: 2337-3539 (2301-9271 Print).
- [2] Lee, S. J., & Kim, M. H. 2008. The Effects Of Tank *Sloshing* On LNG Vessel And Floating Terminal Responses. [Draft] IWWWFB.
- [3] Belakroum, R., et. al. 2010. An Efficient Passive Technique for Reducing *Sloshing* In Rectangular Tanks Partially Filled With Liquid. *Mechanics Research Communications*.
- [4] Jung, J. H., et. al 2012. Effect Of The Vertical Baffle Height On The Liquid *Sloshing* In A Three-Dimensional Rectangular Tank. *Ocean Engineering*.
- [5] Thabet, S., et. al. 2018. Computational Fluid Dynamics: Science of the Future. *International Journal of Research and Engineering*.
- [6] Fatchurrohman, N., & Chia, S. T. 2017. Performance of hybrid nano-micro reinforced mg metal matrix composites brake calliper: Simulation approach. *IOP Conference Series: Materials Science and Engineering*.
- [7] Subagyo, Rachmat. 2018. *Mekanika Fluida I*. Banjarbaru: Fakultas Teknik - Universitas Lambung Mangkurat.
- [8] Ghurri, Ainul. 2014. *Dasar-Dasar Mekanikal Fluida*. Bali: Jurusan Teknik Mesin - Universitas Udayana.
- [9] Rognebakke, O., et. al. 2009. *Sloshing Impact Design Load Assessment*. *Proceedings of the Nineteenth (2009) International Offshore and Polar Engineering Conference*. Osaka, Japan, June 21-26, 2009.
- [10] Jin, H., et. al. 2014. Experimental study on *sloshing* in a tank with an inner horizontal perforated plate. *Ocean Engineering*.

APPENDIX

- Drawing 2D Fuel Tank Design

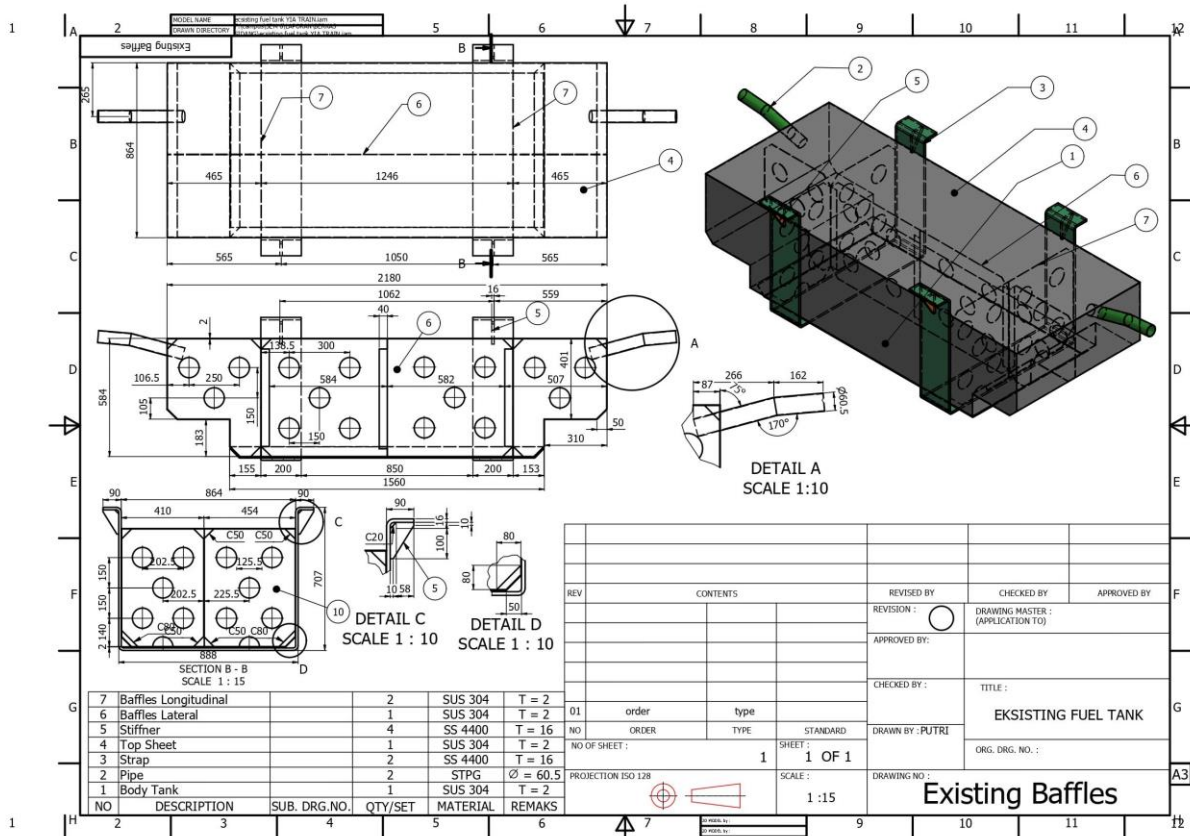

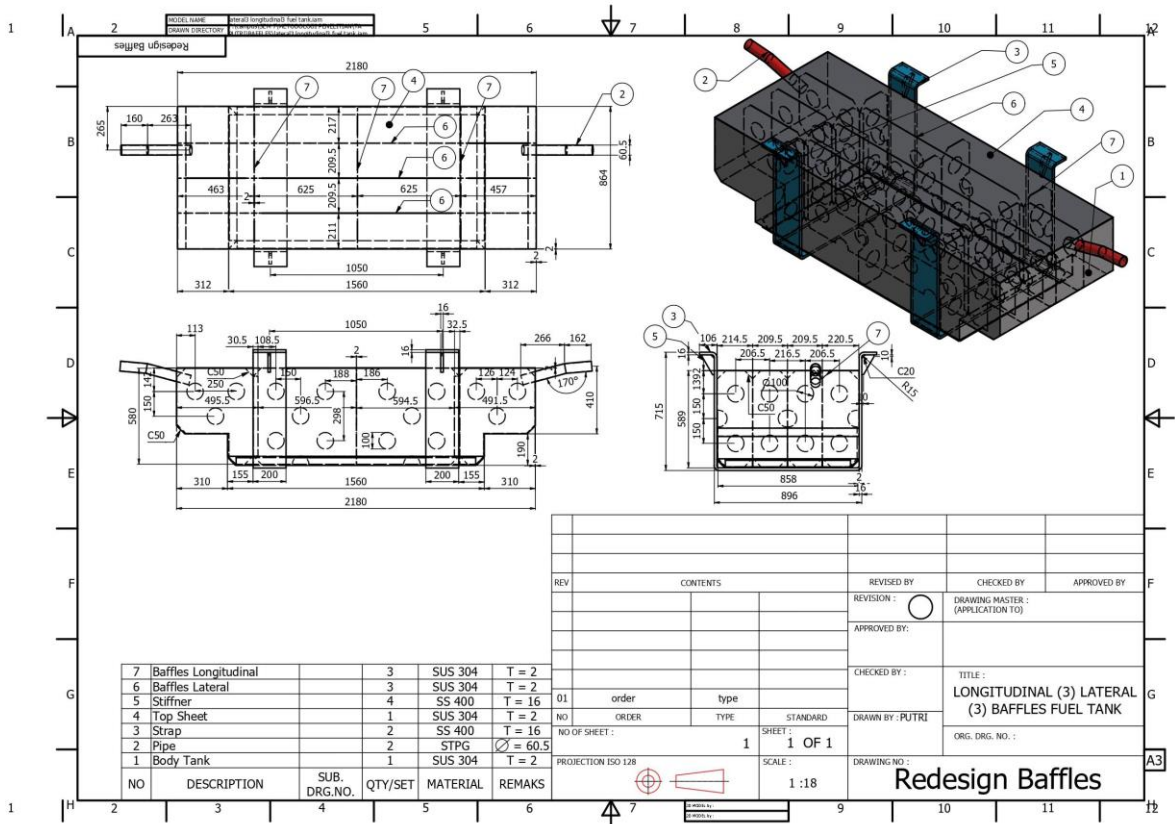

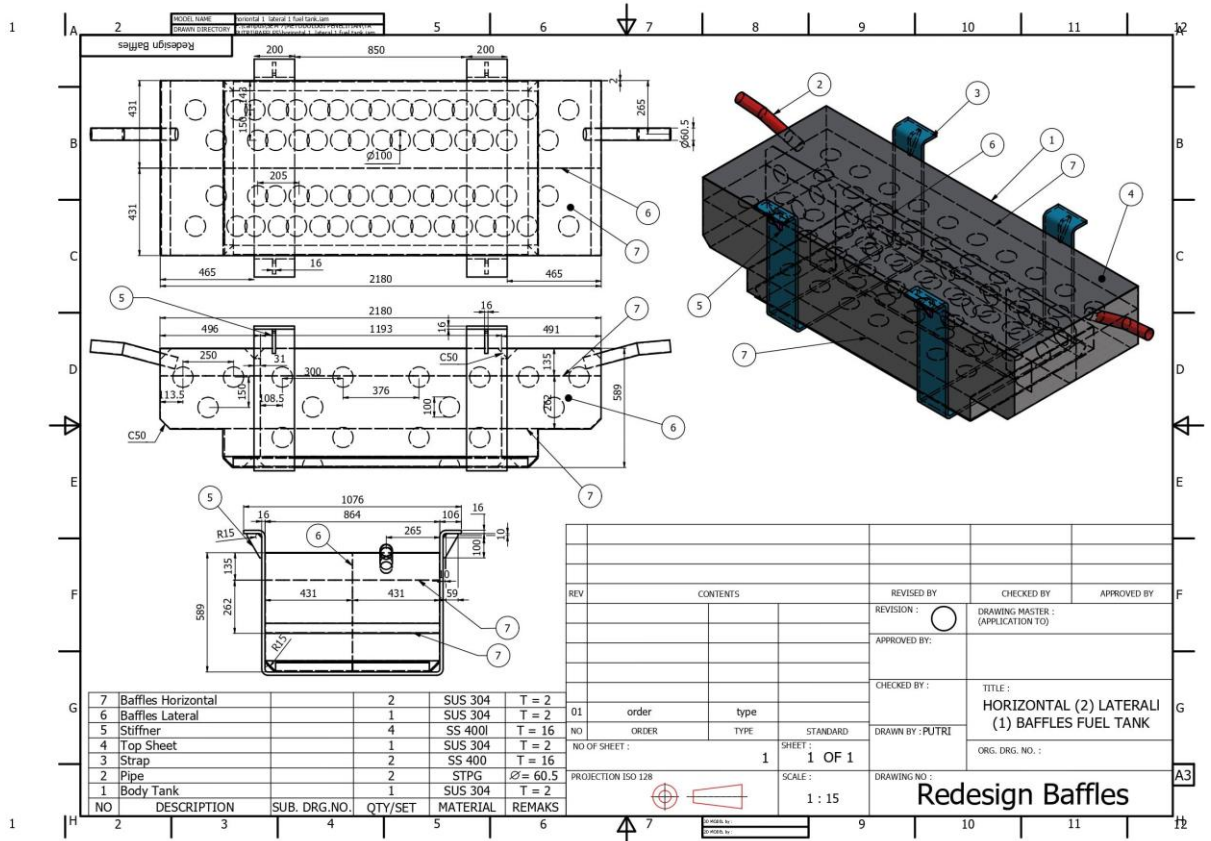

- **Fluid Movement in Four Variations of Tank Baffles**

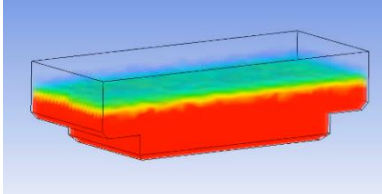
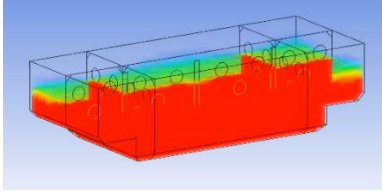
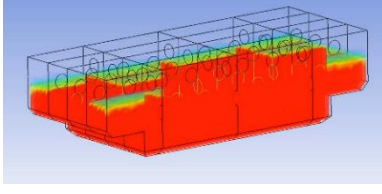
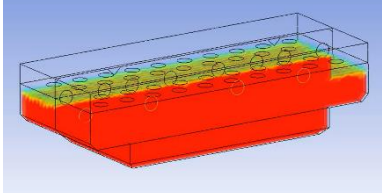
$t = 0 \text{ s}$	
Tank without baffles	
Existing baffles	
Longitudinal (3) - lateral (3) baffles	
Horizontal (2) - lateral (1) baffles	

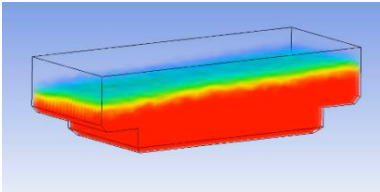
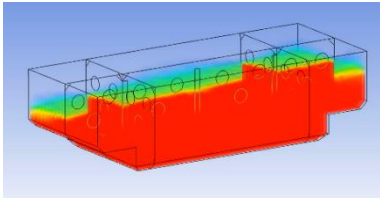
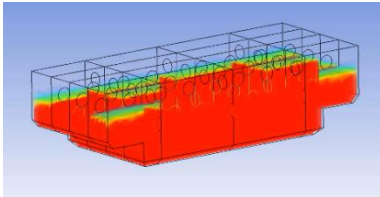
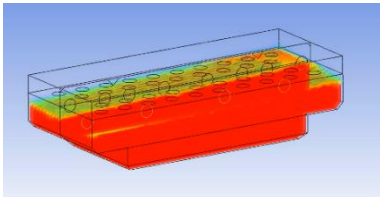
$t = 1 \text{ s}$	
Tank without baffles	
Existing baffles	
Longitudinal (3) - lateral (3) baffles	
Horizontal (2) - lateral (1) baffles	

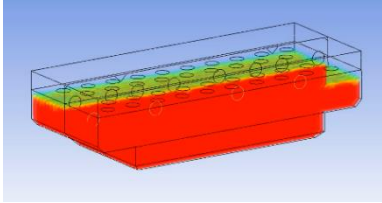
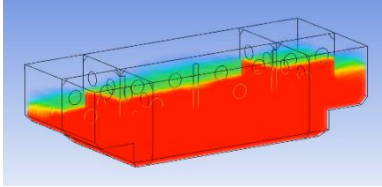
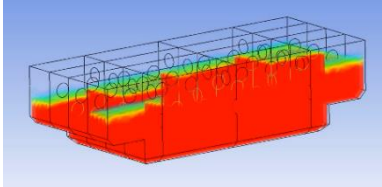
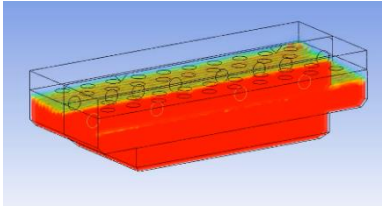
$t = 2 \text{ s}$	
Tank without baffles	
Existing baffles	
Longitudinal (3) - lateral (3) baffles	
Horizontal (2) - lateral (1) baffles	

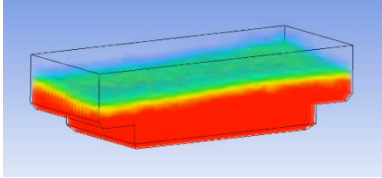
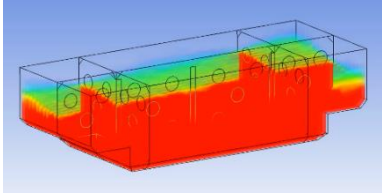
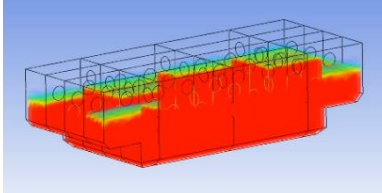
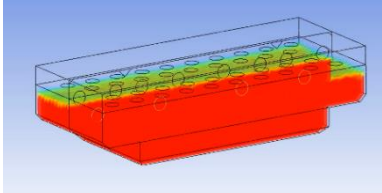
$t = 3 \text{ s}$	
Tank without baffles	
Existing baffles	
Longitudinal (3) - lateral (3) baffles	
Horizontal (2) - lateral (1) baffles	

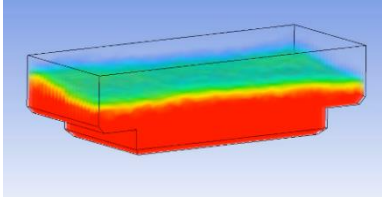
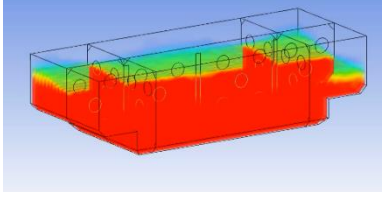
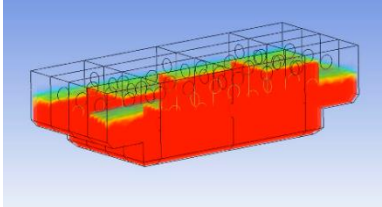
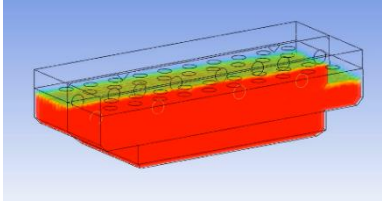
$t = 4 \text{ s}$	
Tank without baffles	
Existing baffles	
Longitudinal (3) - lateral (3) baffles	
Horizontal (2) - lateral (1) baffles	

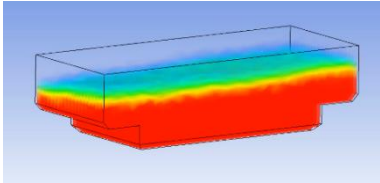
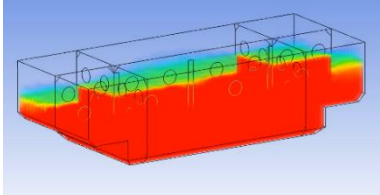
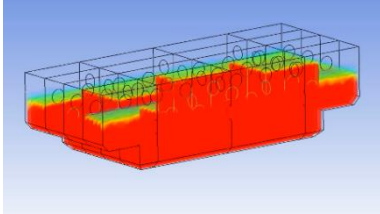
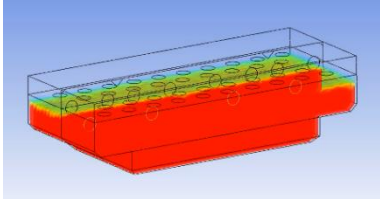
$t = 5 \text{ s}$	
Tank without baffles	
Existing baffles	
Longitudinal (3) - lateral (3) baffles	
Horizontal (2) - lateral (1) baffles	

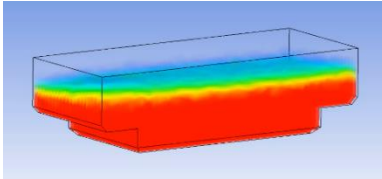
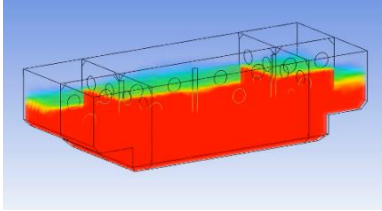
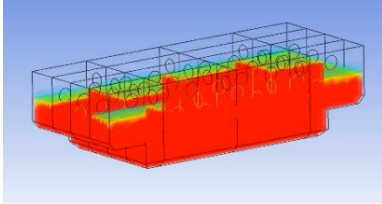
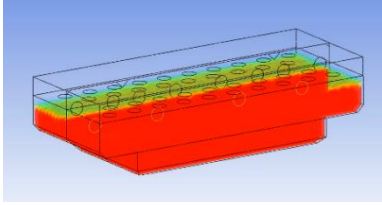
$t = 6 \text{ s}$	
Tank without baffles	
Existing baffles	
Longitudinal (3) - lateral (3) baffles	
Horizontal (2) - lateral (1) baffles	

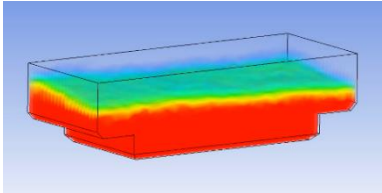
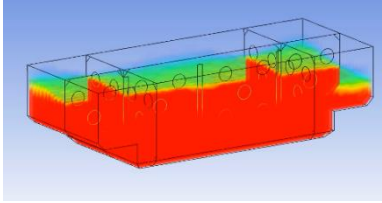
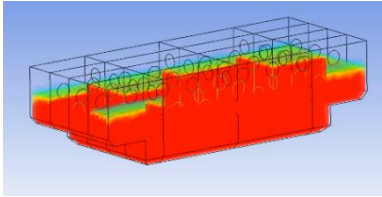
$t = 7 \text{ s}$	
Tank without baffles	
Existing baffles	
Longitudinal (3) - lateral (3) baffles	
Horizontal (2) - lateral (1) baffles	